

INSTRUCTION MANUAL

Orion® StarBlast™ II 4.5 EQ

#9250 Equatorial Newtonian Reflector Telescope



 **ORION**®
TELESCOPES & BINOCULARS
AN EMPLOYEE-OWNED COMPANY

Corporate Offices: 89 Hangar Way, Watsonville CA 95076 - USA

Toll Free USA & Canada: (800) 447-1001

International: +1(831) 763-7000

Customer Support: support@telescope.com

Copyright © 2022 Orion Telescopes & Binoculars. All Rights Reserved. No part of this product instruction or any of its contents may be reproduced, copied, modified or adapted, without the prior written consent of Orion Telescopes & Binoculars.

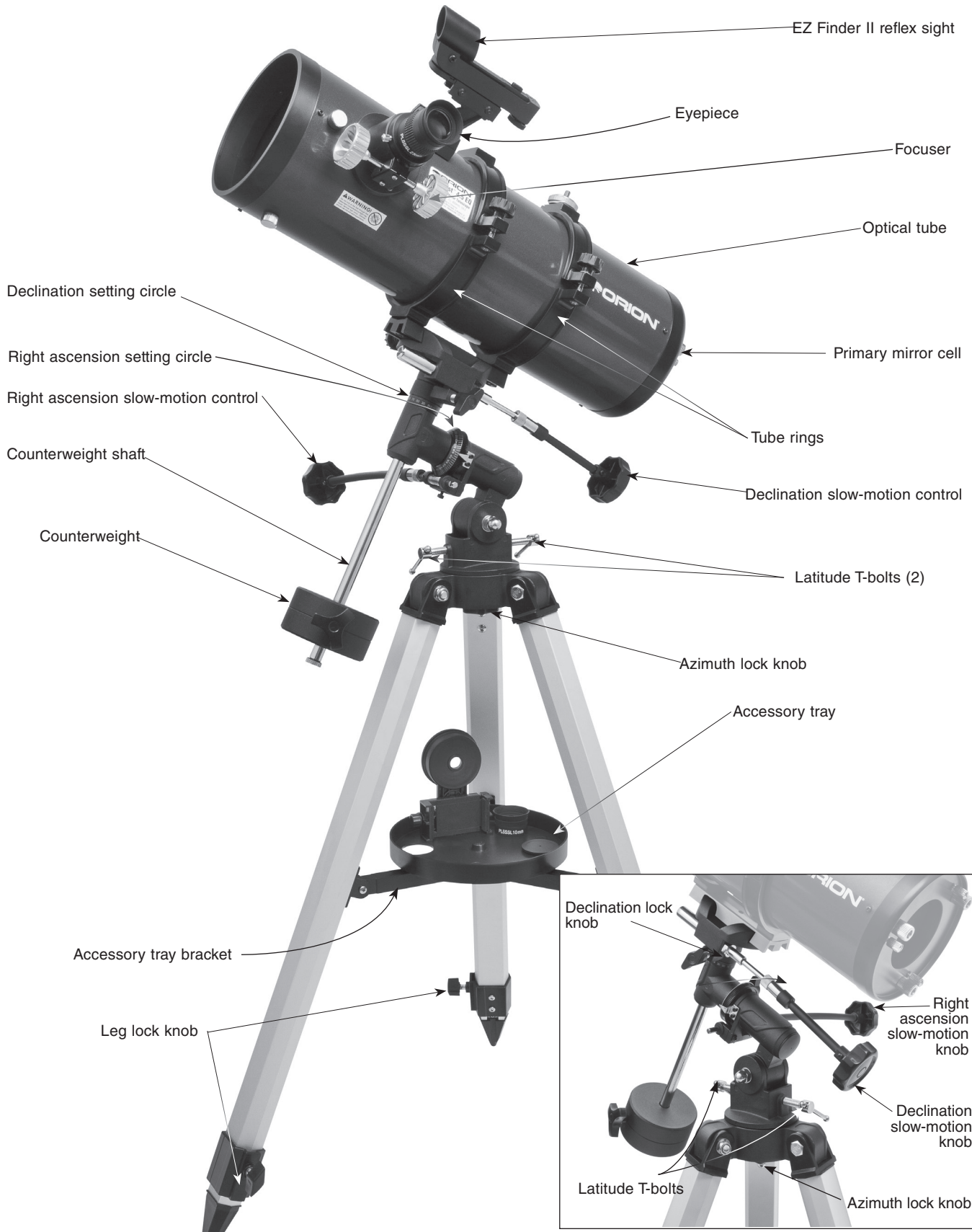

Figure 1a. The StarBlast II 4.5 EQ

Figure 1a. The StarBlast II 4.5 EQ

Congratulations on your purchase of an Orion telescope. Your new StarBlast II 4.5 EQ is a terrific starter instrument for exploring the exotic wonders of the night sky. Designed to be compact and easy to use, it will provide many hours of enjoyment for the whole family. If you have never owned a telescope before, we would like to welcome you to amateur astronomy. Take some time to familiarize yourself with the night sky. Learn to recognize the patterns of stars in the major constellations. With a little practice, a little patience, and a reasonably dark sky away from city lights, you'll find your telescope to be a never-ending source of wonder, exploration, and relaxation. These instructions will help you set up, properly use, and care for your telescope. Please read them over thoroughly before getting started.

Table of Contents

1. Unpacking	3
2. Parts List	3
3. Assembly	3
4. Getting Started	4
5. Setting Up and Using the Equatorial Mount	7
6. Collimating the Optics	10
7. Astronomical Observing	11
8. Care and Maintenance	13
9. Specifications	14

1	Equatorial mount
2	Latitude adjustment T-bolt
2	Slow-motion control cables
1	Tripod assembly
1	Tripod accessory tray
1	Counterweight shaft
1	Counterweight
1	EZ Finder II reflex sight with mounting bracket
1	25mm Plossl eyepiece
1	10mm Plossl eyepiece
1	Collimating cap
1	DeepMap 600
1	MoonMap 260
1	Smartphone camera adapter

WARNING: *Never look directly at the Sun through your telescope—even for an instant—without a professionally made solar filter that completely covers the front of the instrument, or permanent eye damage could result. Young children should use this telescope only with adult supervision.*

1. Unpacking

The entire telescope system will arrive in one box. Be careful unpacking the box. We recommend keeping the original shipping containers. In the event that the telescope needs to be shipped to another location, or returned to Orion for warranty repair, having the proper shipping containers will help ensure your telescope will survive the journey intact. Make sure all the parts in the Parts List are present. Be sure to check boxes carefully, as some parts are small. If anything appears to be missing or broken, immediately call Orion Customer Support (800-447-1001) for assistance.

2. Parts List

Qty.	Description
1	Optical tube assembly
2	Tube mounting rings
1	Dovetail mounting bar

3. Assembly

Assembling the telescope for the first time should take about 30 minutes. All screws should be tightened securely to eliminate flexing and wobbling, but be careful not to over-tighten or the threads may strip. Refer to **Figures 1a.** and **1b.** during assembly. During assembly (and anytime, for that matter), do not touch the surfaces of the telescope mirrors or the lenses of the EZ Finder II or eyepieces with your fingers; the optical surfaces have coatings on them that can be damaged. Never remove any lens assembly from its housing for any reason, or the product warranty and return policy will be void.

1. Open the tripod assembly to its widest spread and stand it on the floor.
2. Tighten the leg lock knobs on the bottom braces of the tripod legs. For now, keep the legs at their shortest (fully retracted) length; you can extend them to a more desirable length later, after the tripod is completely assembled.
3. Attach the accessory tray to the accessory tray bracket by simply placing it over the center of the bracket between the tripod legs and rotating until it locks in place.
4. Place the EQ mount head on top of the tripod, and secure it in place by threading in the large hand knob up from



Figure 2. Attach the EQ head to the tripod by threaded the large thumb knob up from below until the EQ head is snug against the tripod.

below into the bottom of the mount head until snug (**Figure 2**).

5. Install both latitude adjustment T-bolts into the threaded hole in the front and rear of the mount (**Figure 3**). One or both T-bolts may come separate in your telescope shipping box - one threads into the north side of the mount, the other into the south side. If both are already attached, ignore this step.
6. Thread the counterweight shaft into the equatorial mount at the base of the declination axis until tight.
7. Remove the screw on the bottom of the counterweight

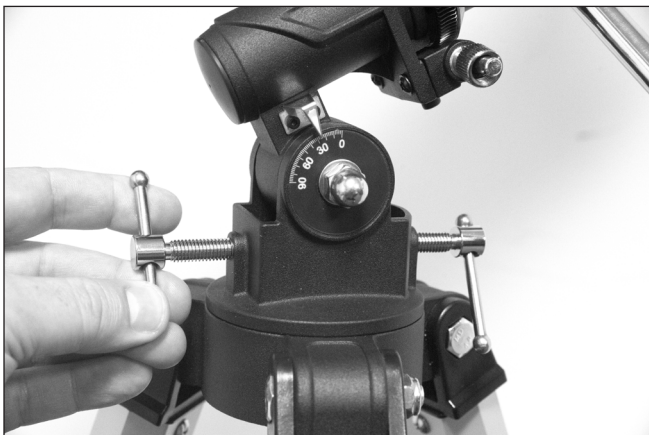

Figure 2. Attach the EQ head to the tripod by threaded the large thumb knob up from below until the EQ head is snug against the tripod.

shaft and slide the counterweight onto the shaft. Make sure the counterweight lock knob is adequately loosened to allow the counterweight shaft to pass through the hole. Position the counterweight about halfway up the shaft and

tighten the lock knob. Replace the screw on the end of the shaft.

8. The tube rings and dovetail bar come attached to the optical tube. Simply lower the dovetail bar into the mating cradle on the top of the EQ mount (**Figure 1b**), and secure by tightening the two thumbscrews against the side wall of the dovetail.
9. Attach the two slow-motion control cables to the R.A. and Dec. worm gear shafts of the equatorial mount by positioning the pin on the end of the cables into the cutout slot on the worm gear shafts and then threading the collar down onto each cables. Either cable will work on either the Dec or R.A. axis - it is personal preference how you want it positioned.
10. Before installing the EZ Finder II, see "Installing the Battery in the EZ Finder II" in Section 4. Once the battery is installed, oriented as in **Figure 4**, simply slip it into the dovetail finder bracket on the side of the optical tube. Gently tighten down the thumbscrew to hold it in place.
11. Remove the cap from the focuser and insert the 25mm eyepiece into the focuser drawtube by slipping it straight in. Secure it in place with the thumbscrews on the end of the drawtube.

Your StarBlast II 4.5 EQ is now fully assembled and should resemble **Figure 1a**. Leave the dust cover on the front of the optical tube when it is not in use.

4. Getting Started

Now that the StarBlast II 4.5 is assembled, the next things to do are to balance the telescope about its axes of motion, and to align the reflex sight with the telescope.

Balancing the Telescope

To ensure smooth movement of the telescope on both axes of the equatorial mount, it is imperative that the optical tube be properly balanced. First balance the telescope with respect to the R.A. axis, then the Dec. axis.

1. Keeping one hand on the telescope optical tube, loosen the R.A. lock knob. Make sure the Dec. lock knob is locked, for now. The telescope should now be able to rotate freely about the R.A. axis. Rotate it until the counterweight shaft is parallel to the ground (i.e., horizontal).
2. Now loosen the counterweight lock knob and slide the weight along the shaft until it exactly counterbalances the telescope (**Figure 4a**). That's the point at which the shaft remains horizontal even when you let go of the telescope with both hands.
3. Retighten the counterweight lock knob. The telescope is now balanced on the R.A. axis.
4. To balance the telescope on the Dec. axis, first tighten the R.A. lock knob, with the counterweight shaft still in the horizontal position.

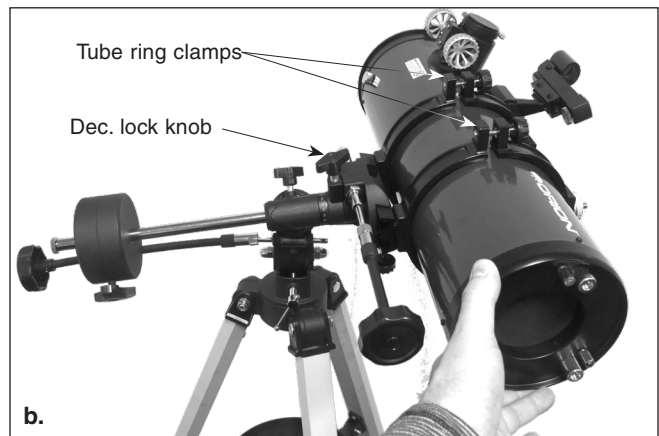
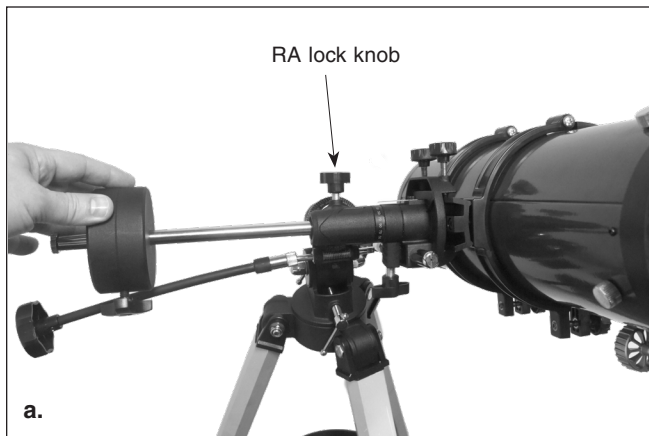

Figure 4. Proper usage of the equatorial mount requires the telescope tube to be balanced on both the R.A. and Dec. axes. **(a)** With the R.A. lock knob released, slide the counterweight along the counterweight shaft until it just counterbalances the tube. When you let go with both hands, the tube should not drift up or down. **(b)** With the Dec. lock knob released, loosen the tube ring lock clamps a few turns and slide the telescope forward or back in the tube rings. When the tube is balanced about the Dec. axis, it will not move when you let go.

5. With one hand on the telescope optical tube, loosen the Dec. lock knob. The telescope should now be able to rotate freely about the Dec. axis (**Figure 4b**). Loosen the knurled tube ring clamps a few turns, until you can slide the telescope tube forward and back inside the rings. Using a slight twisting motion on the optical tube can help move the tube within the rings.
6. Position the telescope so it remains horizontal when you carefully let go with both hands. This is the balance point. Before clamping the tube rings tight again, rotate the telescope so the eyepiece is at a convenient angle for viewing. When you are actually observing with the telescope, you can adjust the eyepiece position by loosening the tube rings and rotating the optical tube.
7. Retighten the tube ring clamps.

The telescope is now balanced in both axes. Now when you loosen the lock knob on one or both axes and manually point the telescope, it should move without resistance and should not drift from where you point it.

Focusing the Telescope

With the 25mm eyepiece in the focuser, move the telescope so the front (open) end is pointing in the general direction of an object at least 1/4-mile away. Now with your fingers, slowly rotate one of the focusing knobs until the object comes into sharp focus. Go a little bit beyond sharp focus until the image starts to blur again, then reverse the rotation of the knob, just to make sure you've hit the exact focus point.

Do You Wear Eyeglasses?

If you wear eyeglasses, you may be able to keep them on while you observe. In order to do this, your eyepiece must have enough "eye relief" to allow you to see the entire field of view with glasses on. You can try this by looking through the eyepiece first with your glasses on and then with them off, and see if the glasses restrict the view to only a portion of the full field. If the glasses do restrict the field of view, you may be able to observe with your glasses off by just refocusing the telescope.

If your eyes are astigmatic, however, images will probably appear better with glasses on. This is because a telescope's focuser can accommodate for nearsightedness or farsightedness, but not astigmatism. If you have to wear your glasses while observing and cannot see the entire field of view, you may want to consider purchasing special eyepieces that have extra-long eye relief.

Operating the EZ Finder II Reflex Sight

The EZ Finder II reflex sight (**Figure 5**) makes pointing your telescope almost as easy as pointing your finger! It's a non-magnifying aiming device that superimposes a tiny red dot on the sky, showing exactly where the telescope is pointed.

Installing the Battery in the EZ Finder II

Before installing the EZ Finder II on the telescope, you will need to insert the included CR2032 3V lithium button cell battery in the EZ Finder II. If there is a small plastic tab sticking out from the battery compartment cover, you must remove it for the battery to make contact with the EZ Finder's electronic circuitry. The tab can then be discarded.

1. Turn the EZ Finder II upside down as shown in **Figure 6a**.
2. Insert a small, flat-blade screwdriver into the notch in the battery compartment cover and gently pry it off.
3. Slide the battery under the retaining clip with the positive (+) side facing outward (touching the clip) (**6b**).
4. Then press the battery compartment cover back on. Should the battery die, replacement CR2032 batteries are available at many stores where small batteries are sold or online.

The EZ Finder II works by projecting a tiny red dot (it's not a laser beam) onto a lens mounted in the front of the unit. When you look through the EZ Finder II, the red dot will appear to float in space, helping you locate even the faintest of deep-sky objects (**Figure 7**). The red dot is produced by a light-emitting diode (LED) near the rear of the sight.

Turn the power knob clockwise until you hear the "click" indicating power has been turned on. Look through the rear of the

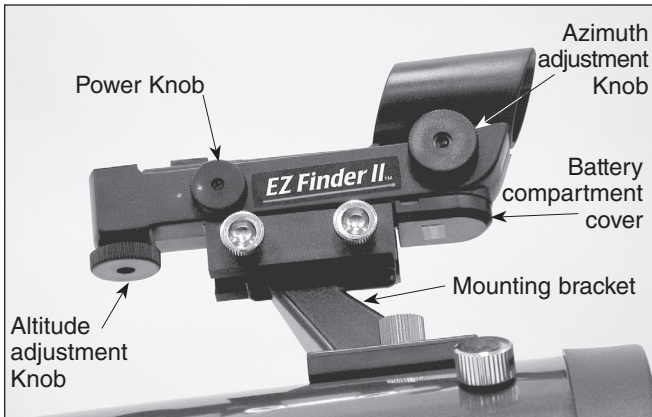

Figure 5. The EZ Finder II reflex sight.

reflex sight with both eyes open to see the red dot. Position your eye at a comfortable distance from the rear of the sight. The intensity of the dot is adjusted by turning the power knob. For best results when stargazing, use the dimmest possible setting that allows you to see the dot without difficulty. Typically a dimmer setting is used under dark skies and a brighter setting is used under light-polluted skies or daylight.

At the end of your observing session, be sure to turn the power knob counterclockwise until it clicks off. When the white dots on the reflex sight's body and power knob are lined up, the EZ Finder II is turned off.

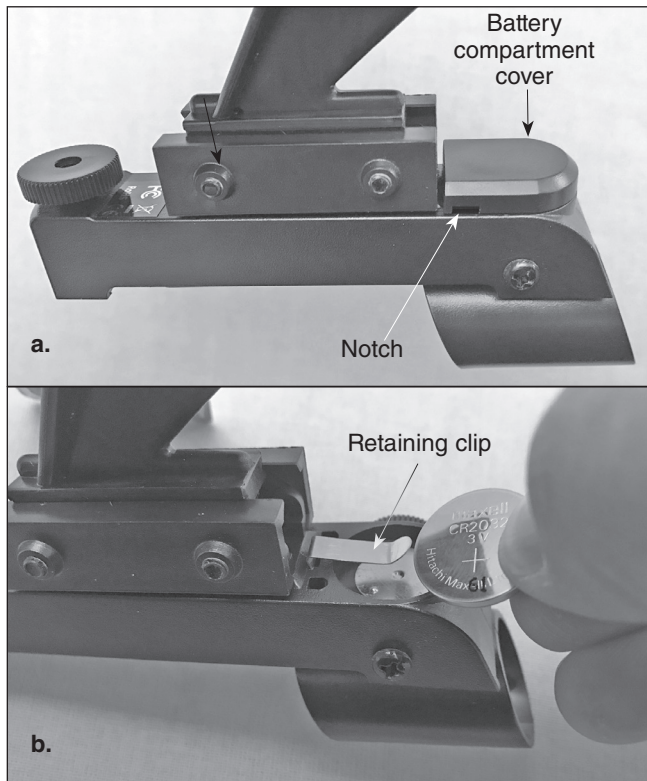

Figure 6. a) To install the CR2032 battery in the EZ Finder II, first turn it upside-down and remove the battery compartment cover. **b)** Install the battery with positive (+) side facing outward, as shown.

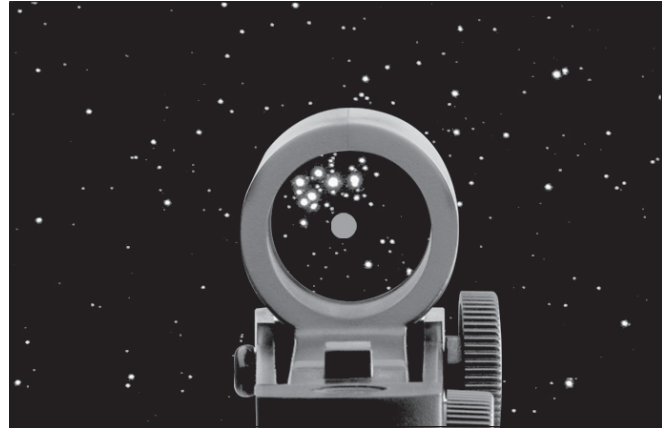

Figure 7. The EZ Finder II superimposes a small red dot (it's not a laser!) on a non-magnified field of view, which helps to center an object in the telescope's field of view.



Figure 8. The view through a reflector telescope is rotated 180°

Aligning the EZ Finder II Reflex Sight

When the EZ Finder II is properly aligned with the telescope, an object that is centered on the reflex sight's red dot should also appear in the center of the field of view of the telescope's eyepiece. Alignment of the EZ Finder II is easiest during daylight, before observing at night. Aim the telescope at a distant object such as a telephone pole or roof chimney and center it in the telescope's eyepiece. The object should be at least 1/4 mile away. Now, with the EZ Finder turned on, look through the EZ Finder II. The object will appear in the field of view near the red dot.

Note: The image in the telescope will appear upside-down (rotated 180°). This is normal for reflector telescopes (Figure 8).

Without moving the telescope, use the reflex sight's azimuth (left/right) and altitude (up/down) adjustment knobs to position the red dot on the object in the eyepiece.

When the red dot is centered on the distant object, check to make sure the object is still centered in the telescope's field of view. If not, re-center it and adjust the reflex sight's alignment again. When the

object is centered in the eyepiece and on the reflex sight's red dot, the EZ Finder II is properly aligned with the telescope.

The reflex sight's alignment should be checked before every observing session. Choose any bright star or planet, center the object in the telescope's eyepiece, then adjust the knobs until the object is centered on the red dot of the EZ Finder II.

5. Setting Up and Using the Equatorial Mount

When you look at the night sky, you no doubt have noticed the stars appear to move slowly from east to west over time. That apparent motion is caused by the Earth's rotation (from west to east). An equatorial mount (**Figure 1b**) is designed to compensate for that motion, allowing you to easily "track" the movement of astronomical objects, thereby keeping them from drifting out of the telescope's field of view while you're observing.

This is accomplished by slowly rotating the telescope on its right ascension (R.A.) axis, using only the R.A. slow-motion cable. But first the R.A. axis of the mount must be aligned with the Earth's rotational (polar) axis—a process called polar alignment.

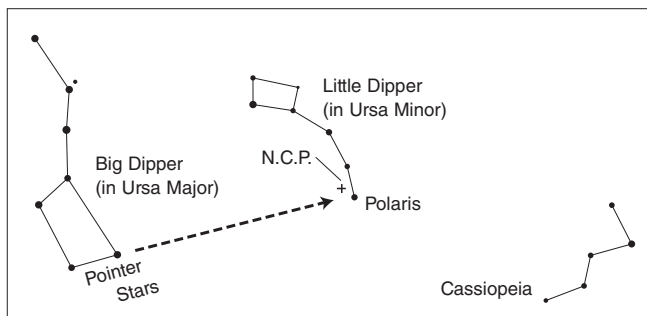

Figure 9. To find Polaris in the night sky, look north and find the Big Dipper. Extend an imaginary line from the two "Pointer Stars" in the bowl of the Big Dipper. Go about five times the distance between those stars and you'll reach Polaris, which lies within 1° of the north celestial pole (NCP).

Polar Alignment

For Northern Hemisphere observers, approximate polar alignment is achieved by pointing the mount's right ascension axis at the North Star (Polaris). It lies within 1° of the north celestial pole (NCP), which is an extension of the Earth's rotational axis out into space. Stars in the Northern Hemisphere appear to revolve around the NCP.

To find Polaris in the sky, look north and locate the pattern of the Big Dipper (**Figure 9**). The two stars at the end of the "bowl" of the Big Dipper point right to Polaris.

Observers in the Southern Hemisphere aren't so fortunate to have a bright star so near the south celestial pole (SCP). The star Sigma Octantis lies about 1° from the SCP, but it is barely visible with the naked eye (magnitude 5.5).

To polar align the StarBlast II 4.5 EQ:

1. Level the equatorial mount by adjusting the length of the three tripod legs.

2. Loosen the latitude lock T-bolt closest to the counterweight shaft. Then loosen or tighten the opposite T-bolt to raise or lower the Altitude axis until the pointer on the latitude scale is indicating the latitude of your observing site. If you don't know your latitude, consult a geographical atlas to find it. For example, if your latitude is 35° North, set the pointer to 35. The latitude setting should not have to be adjusted again unless you move to a different viewing location some distance away. Once you have it set, tighten back down the T-bolt closest to the counterweight shaft (the north t-bolt) to hold the altitude axis securely in place.
3. Loosen the Dec. lock knob and rotate the telescope optical tube until it is parallel with the R.A. axis, as it is in **Figure 1a**. The pointer on the Dec. setting circle should read 90°. Retighten the Dec. lock lever.
4. Loosen the azimuth lock knob (underneath the EQ head) slightly, and rotate the mount so the telescope tube (and R.A. axis) points roughly at Polaris. If you cannot see Polaris directly from your observing site, consult a compass and rotate the mount so the telescope points North. Retighten the azimuth lock knob.

The equatorial mount is now polar aligned. From this point on in your observing session, you should not make any further adjustments to the azimuth or the latitude of the mount, nor should you move the tripod. Doing so will undo the polar alignment. The telescope should be moved only about its R.A. and Dec. axes.

Use of the R.A. and Dec. Slow-Motion Control Cables

The R.A. and Dec. slow-motion control cables allow fine adjustment of the telescope's position to center objects within the field of view. Before you can use the cables, you must manually "slew" the mount to point the telescope in the vicinity of the desired target. Do this by loosening the R.A. and Dec. lock knobs and moving the telescope about the mount's R.A. and Dec. axes. Once the telescope is pointed somewhere close to the object to be viewed, retighten the mount's R.A. and Dec. lock knobs.

The object should now be visible somewhere in the EZ Finder II. If it isn't, use the slow-motion controls to scan the surrounding area of sky. When the object is visible in the EZ Finder II, use the slow-motion controls to center the red dot on it. Now, look in the telescope's eyepiece. If the EZ Finder II is properly aligned, the object should be visible somewhere in the field of view. Once the object is visible in the eyepiece, use the slow-motion controls to center it in the field of view.

The Dec. slow-motion control cable can move the telescope a maximum of 25°. This is because the Dec. slow-motion mechanism has a limited range of mechanical travel. (The R.A. slow-motion mechanism has no limit to its amount of travel.) If you can no longer rotate the Dec. control cable in a desired direction, you have reached the end of travel, and the slow-motion mechanism must be reset. This is done by first rotating the control cable several turns in the opposite direction from which it was being turned. Then, manually slew the telescope closer to the object you wish to observe (remember to first loosen the Dec. lock knob). You should now be able to use the Dec. slow-motion control cable again to fine adjust the telescope's position.

Tracking Celestial Objects

When you observe a celestial object through the telescope, you'll see it drift slowly across the field of view. To keep it in the field, assuming your equatorial mount is polar aligned, just turn the R.A. slow-motion control cable clockwise. The Dec. slow-motion control cable is not needed for tracking. Objects will appear to move faster at higher magnifications, because the field of view is narrower.

Optional Electronic Drives for Automatic Tracking

An optional DC electronic drive can be mounted on the R.A. axis of the equatorial mount to provide hands-free tracking. Objects will then remain stationary in the field of view without any manual adjustment of the R.A. slow-motion control cable.

Understanding the Setting Circles

The setting circles on an equatorial mount enable you to locate celestial objects by their "celestial coordinates." Every object resides in a specific location on the "celestial sphere." That location is denoted by two numbers: its right ascension (R.A.) and declination (Dec.). In the same way, every location on Earth can be described by its longitude and latitude. R.A. is similar to longitude on Earth, and Dec. is similar to latitude. The R.A. and Dec. values for celestial objects can be found in any star atlas or star catalog.

The mount's R.A. setting circle is scaled in hours, from 1 through 24, with small marks in between representing 10-minute increments. The numbers closest to the R.A. axis gear apply to viewing in the Southern Hemisphere, while the numbers above them apply to viewing in the Northern Hemisphere.

The Dec. setting circle is scaled in degrees, with each mark representing 2.5° increments. Values of Dec. coordinates range from +90° to -90°. The 0° mark indicates the celestial equator. When the telescope is pointed north of the celestial equator, values of the Dec. setting circle are positive, while when the telescope is pointed south of the celestial equator, values of the Dec. setting circle are negative.

So, the coordinates for the Orion Nebula listed in a star atlas will look like this:

R.A. 5h 35.4m Dec. -5° 27'

That's 5 hours and 35.4 minutes in right ascension, and -5 degrees and 27 arc-minutes in declination (there are 60 arc-minutes in 1 degree of declination).

Before you can use the setting circles to locate objects, the mount must be properly polar aligned, and the R.A. setting circle must be calibrated. The Dec. setting circle has been permanently calibrated at the factory, and should read 90° whenever the telescope optical tube is parallel with the R.A. axis.

Calibrating the Right Ascension Setting Circle

1. Identify a bright star in the sky near the celestial equator (Dec. = 0°) and look up its coordinates in a star atlas.
2. Loosen the R.A. and Dec. lock knobs on the equatorial mount, so the telescope optical tube can move freely.

3. Point the telescope at the bright star whose coordinates you know. Lock the R.A. and Dec. lock knobs. Center the star in the telescope's field of view with the slow-motion control cables.
4. Rotate the setting circle until the metal arrow indicates the R.A. coordinate listed in the star atlas for the object.

Finding Objects with the Setting Circles

1. Now that both setting circles are calibrated, look up in a star atlas the coordinates of an object you wish to view.
2. Loosen the R.A. lock knob and rotate the telescope until the R.A. value from the star atlas matches the reading on the R.A. setting circle. Remember to use the upper set of numbers on the R.A. setting circle. Retighten the lock knob.
3. Loosen the Dec. lock knob and rotate the telescope until the Dec. value from the star atlas matches the reading on the Dec. setting circle. Remember that values of the Dec. setting circle are positive when the telescope is pointing north of the celestial equator (Dec. = 0°), and negative when the telescope is pointing south of the celestial equator. Retighten the lock knob.

Most setting circles are not accurate enough to put an object dead-center in the telescope's eyepiece, but they should place the object somewhere within the field of view of the EZ Finder II, assuming the equatorial mount is accurately polar aligned. Use the slow-motion controls to center the object in the reflex sight, and it should appear in the telescope's field of view.

The R.A. setting circle must be re-calibrated every time you wish to locate a new object. Do so by calibrating the setting circle for the centered object before moving on to the next one.

Confused About Pointing the Telescope?

Beginners occasionally experience some confusion about how to point the telescope overhead or in other directions. In **Figure 1a** the telescope is pointed north, as it would be during polar alignment. The counterweight shaft is oriented downward. But it will not look like that when the telescope is pointed in other directions. Let's say you want to view an object that is directly overhead, at the zenith. How do you do it?

One thing you DO NOT do is make any adjustment to the latitude adjustment T-bolt. That will nullify the mount's polar alignment. Remember, once the mount is polar aligned, the telescope should be moved only on the R.A. and Dec. axes. To point the scope overhead, first loosen the R.A. lock knob and rotate the telescope on the R.A. axis until the counterweight shaft is horizontal (parallel to the ground). Then loosen the Dec. lock knob and rotate the telescope until it is pointing straight overhead. The counterweight shaft is still horizontal. Then retighten both lock knobs.

Similarly, to point the telescope directly south, the counterweight shaft should again be horizontal. Then you simply rotate the scope on the Dec. axis until it points in the south direction.

What if you need to aim the telescope directly north, but at an object that is nearer to the horizon than Polaris? You can't do it with the counterweight down as pictured in **Figure 1a**. Again,

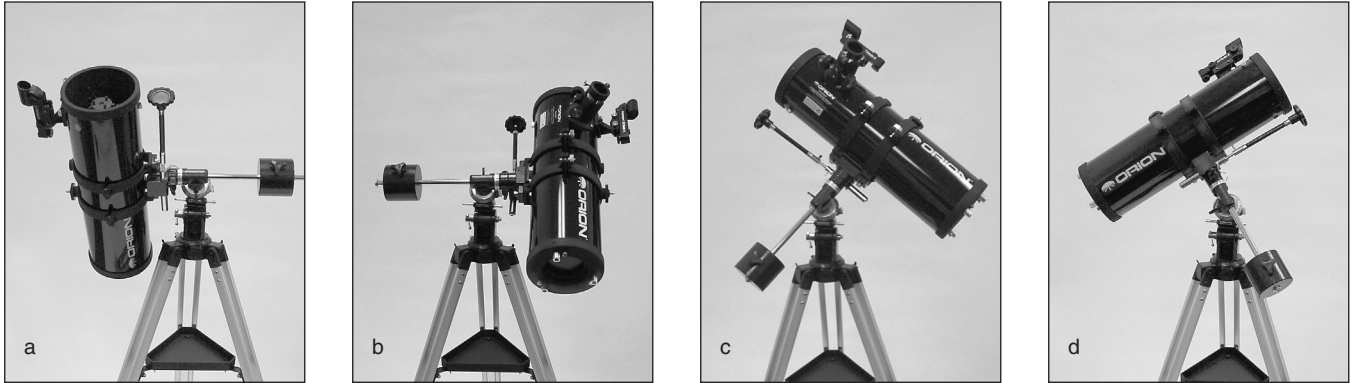

Figure 10. This illustration shows the telescope pointed in the four cardinal directions **(a)** north **(b)** south **(c)** east **(d)** west. Note that the tripod and mount have not been moved; only the telescope tube has been moved in the R.A. and Dec. axes.

you have to rotate the scope in R.A. so the counterweight shaft is positioned horizontally. Then rotate the scope in Dec. so it points to where you want it near the horizon.

To point the telescope to the east or west, or in other directions, you rotate the telescope on its R.A. and Dec. axes. Depending on the altitude of the object you want to observe, the counterweight shaft will be oriented somewhere between vertical and horizontal.

Figure 10 illustrates how the telescope will look pointed at the four cardinal directions—north, south, east, and west

The key things to remember when pointing the telescope is that a) you only move it in R.A. and Dec., not in azimuth or latitude (altitude), and b) the counterweight and shaft will not always appear as it does in **Figure 1a**. In fact, it almost never will!

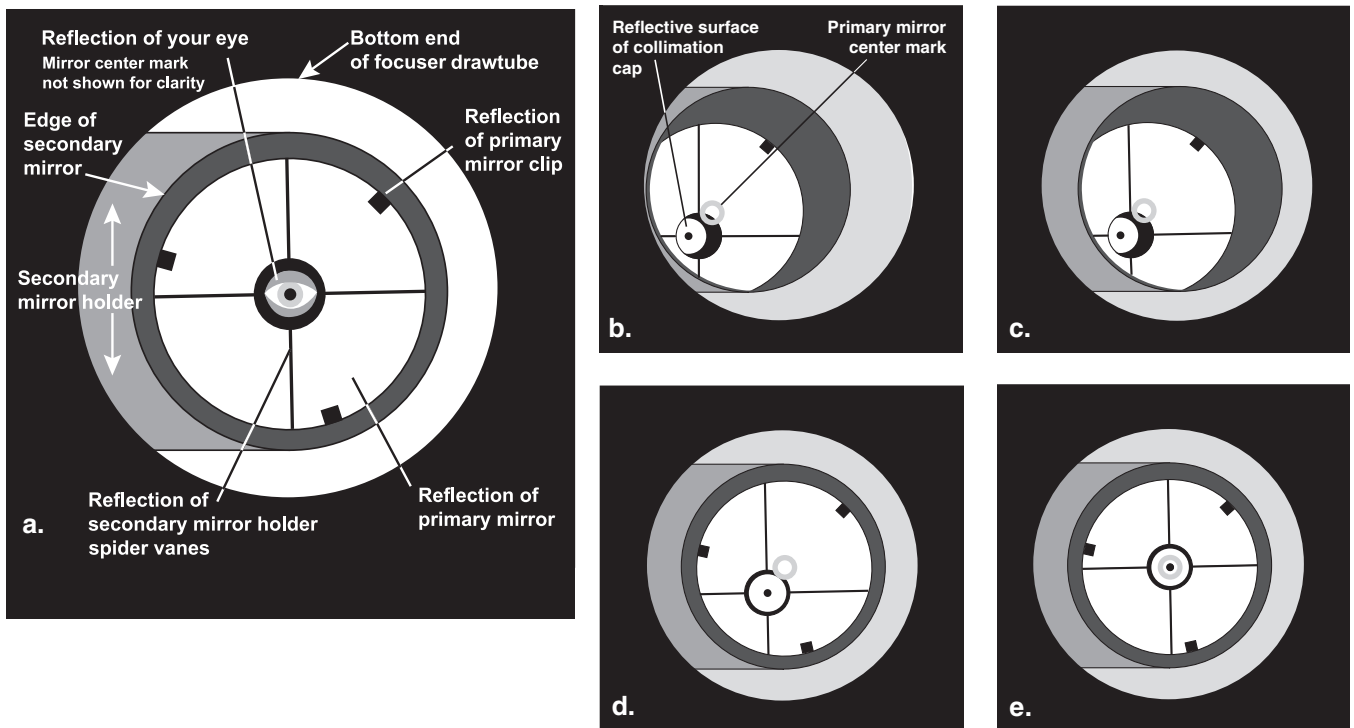

Figure 11. Collimating the optics. **(a)** When the mirrors are properly aligned, the view down the focuser drawtube should look like this. **(b)** With the collimation cap in place, if the optics are out of alignment, the view might look something like this. **(c)** Here, the secondary mirror is centered under the focuser, but it needs to be adjusted (tilted) so that the entire primary mirror is visible. **(d)** The secondary mirror is correctly aligned, but the primary mirror still needs adjustment. When the primary mirror is correctly aligned, the “dot” will be centered, as in **(e)**.

6. Collimating the Optics

Collimating is the process of adjusting the mirrors so they are aligned with one another. Your telescope's optics were aligned at the factory, and should not need much adjustment unless the telescope is handled roughly. Accurate mirror alignment is important to ensure peak performance of your telescope, so it should be checked regularly. Collimating is relatively easy to do and can be done in daylight.

To check optical alignment, remove the eyepiece and look down the focuser drawtube. You should see the secondary mirror centered in the drawtube, as well as the reflection of the primary mirror centered in the secondary mirror, and the reflection of the secondary mirror (and your eye) centered in the reflection of the primary mirror, as in **Figure 11a**. If anything is off-center, proceed with the following collimating procedure.

The Collimating Cap and Primary Mirror Center Mark

Your StarBlast II 4.5 EQ comes with a collimating cap (**Figure 12**). This is a simple cap that fits on the focuser drawtube like a dust cap, but has a hole in the center and a light, reflective surface on the underside. This helps center your eye so collimating is easy to perform. **Figures 11b through 11e** assume you have the collimating cap in place.

In addition to the collimating cap, you'll notice a small ring label on the exact center of the primary mirror. This "center mark" allows you to achieve a very precise alignment of the primary mirror; you don't have to guess where the center of the mirror is.

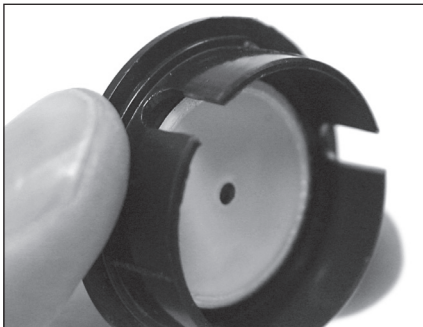

Figure 12. The quick collimation cap, which features a reflective inner surface, helps in centering reflections of the optics in the focuser during the collimation process.

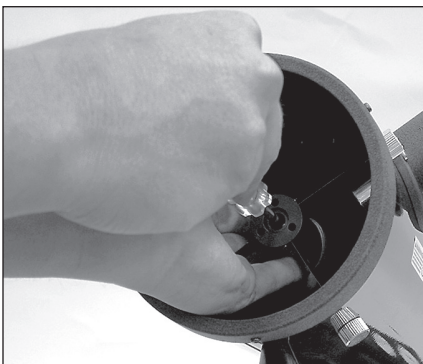

Figure 13. To center the secondary mirror under the focuser, hold the secondary mirror holder in place with your fingers while adjusting the center screw. Do not touch the mirror's surface.

Aligning the Secondary Mirror

It helps to adjust the secondary mirror in a brightly lit room with the telescope pointed toward a bright surface, such as white paper or wall. Placing a piece of white paper in the telescope tube opposite the focuser (i.e. behind the secondary mirror) will also be helpful in collimating the secondary mirror.

With the collimating cap in place, look through the hole in the cap at the secondary (diagonal) mirror. Ignore the reflections for the time being. The secondary mirror itself should be centered in the focuser drawtube. If it isn't, as in **Figure 11b**, it must be adjusted. Typically, this adjustment will rarely, if ever, need to be done.

Note: When making adjustments to the secondary mirror position, be careful not to stress the spider vanes, or they may bend.

To adjust the secondary mirror left-to-right in the focuser drawtube, use a hex key to loosen the three small alignment setscrews in the center hub of the 4-vaned spider several turns. Now hold the mirror holder stationary (be careful not to touch the surface of the mirror), while turning the center screw (**Figure 13**). Turning the screw clockwise will move the secondary mirror toward the front opening of the optical tube, while turning the screw counter-clockwise will move the secondary mirror toward the primary mirror. When the secondary mirror is centered left-to-right in the focuser drawtube, rotate the secondary mirror holder until the reflection of the primary mirror is as centered in the secondary mirror as possible. It may not be perfectly centered, but that is OK for now. Tighten the three small alignment setscrews equally to secure the secondary mirror in that position.

If the entire primary mirror reflection is not visible in the secondary mirror, as in **Figure 11c**, you will need to adjust the tilt of the secondary mirror. This is done by alternately loosening one of the three alignment setscrews while tightening the other two, as depicted in **Figure 14**. The goal is to center the primary mirror reflection in the secondary mirror, as in **Figure 11d**. Don't worry that the reflection of the secondary mirror within the primary mirror reflection (the smallest circle, with the collimation cap "dot" in the center) is off-center. You will fix that in the next step.

Once the secondary mirror is centered in the focuser drawtube, and the primary mirror reflection is centered in the secondary mirror, the secondary mirror is properly aligned, and no further adjustments to it should be needed.

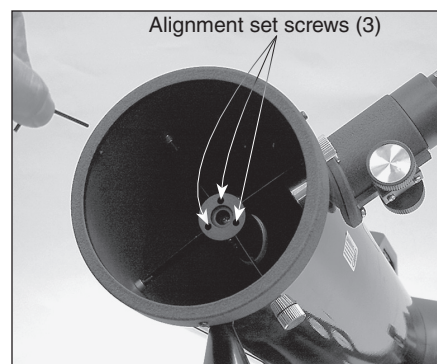

Figure 14. Adjust the tilt of the secondary mirror by loosening one of the three alignment set screws then tightening the other two.

Aligning the Primary Mirror

The final adjustment is made to the primary mirror. It will need adjustment if, as in **Figure 11d**, the secondary mirror is centered in the focuser drawtube and the reflection of the primary mirror is centered in the secondary mirror, but the small reflection of the secondary mirror (with the “dot” of the collimating cap) is off-center.

The tilt of the primary mirror is adjusted with the three large knurled thumbscrews on the rear end of the optical tube (back of the mirror cell) (**Figure 15**). The small thumbscrews (with slots in them) serve to lock the mirror in place. Start by loosening each of these smaller thumbscrews a few turns. Use a screwdriver in the slots, if necessary. Now adjust the tilt of the primary mirror by turning one of the large thumbscrews either clockwise or counterclockwise. Look into the focuser and see if the secondary mirror reflection has moved closer to the center of the primary mirror reflection. You can determine this easily with the collimating cap and primary mirror center mark by simply watching to see if the “dot” of the collimating cap is moving closer or farther away from the “ring” on the primary mirror. If it isn't getting closer, try turning the thumbscrew in the opposite direction. Repeat this process for the other two large thumbscrews, if necessary. It will take a little trial-and-error to get the feel for how to adjust the primary mirror to center the dot of the collimating cap in the ring of the primary

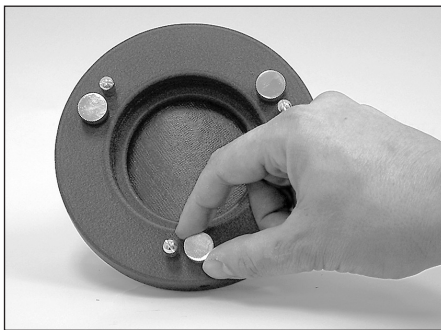

Figure 15. The tilt of the primary mirror is adjusted by turning the three larger thumbscrews.

mirror center mark.

When you have the dot centered as much as possible in the ring, your primary mirror is aligned. The view through the collimating cap should resemble **Figure 11e**. Make sure the smaller thumbscrews on the back of the mirror cell are tightened to lock the primary mirror in position.

A simple star test will tell you whether the optics are, in fact, accurately aligned.

Star-Testing the Telescope

When it is dark, point the telescope at a bright star and accurately center it in the eyepiece's field of view. Slowly de-focus the image with the focus knob. If the telescope's optics are correctly aligned, the expanding disk should be a perfect circle (**Figure 16**). If the image is unsymmetrical, the optics are out of alignment. The dark shadow cast by the secondary mirror should appear in the very center of the out-of-focus circle, like the hole in a donut. If the “hole” appears off-center, the optics are out of alignment.

If you try the star test and the bright star you have selected is not accurately centered in the eyepiece, the telescope will appear to need collimating, even though the optics may be perfectly aligned. It is critical to keep the star centered, so over time you will need to make slight corrections to the telescope's position in order to account for the sky's apparent motion.

7. Astronomical Observing

For many, this will be the first foray into the exciting world of ama-

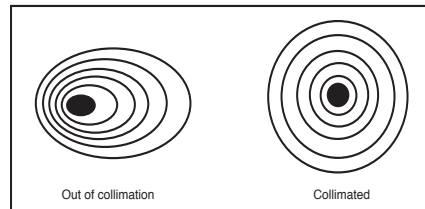

Figure 16. A star test will determine if the telescope's optics are properly collimated. An unfocused view of a bright star through the eyepiece should appear

as illustrated on the right if optics are perfectly collimated. If the circle is unsymmetrical, as illustrated on the left, the scope needs collimation.

teur astronomy. The following information and observing tips will help get you started.

Choosing an Observing Site

When selecting a location for observing, get as far away as possible from direct artificial light such as street lights, porch lights, and automobile headlights. The glare from these lights will greatly impair your dark-adapted night vision. Set up on a grass or dirt surface, not asphalt, because asphalt radiates more heat. Heat disturbs the surrounding air and degrades the images seen through the telescope. Avoid viewing over rooftops and chimneys, as they often have warm air currents rising from them. Similarly, avoid observing from indoors through an open (or closed) window, because the temperature difference between the indoor and outdoor air will cause image blurring and distortion.

If at all possible, escape the light-polluted city sky and head for darker country skies. You'll be amazed at how many more stars and deep-sky objects are visible in a dark sky!

“Seeing” and Transparency

Atmospheric conditions vary significantly from night to night. “Seeing” refers to the steadiness of the Earth's atmosphere at a given time. In conditions of poor seeing, atmospheric turbulence causes objects viewed through the telescope to “boil”. If you look up at the sky and stars are twinkling noticeably, the seeing is poor and you will be limited to viewing at lower magnifications. At higher magnifications, images will not focus clearly. Fine details on the planets and Moon will likely not be visible.

In conditions of good seeing, star twinkling is minimal and images appear steady in the eyepiece. Seeing is best overhead, worst at the horizon. Also, seeing generally gets better after midnight, when much of the heat absorbed by the Earth during the day has radiated off into space.

Especially important for observing faint objects is good “transparency”—air free of moisture, smoke, and dust. All tend to scatter light, which reduces an object’s brightness. Transparency is judged by the magnitude of the faintest stars you can see with the unaided eye (6th magnitude or fainter is desirable).

Cooling the Telescope

All optical instruments need time to reach “thermal equilibrium.” The bigger the instrument and the larger the temperature change, the more time is needed. Allow at least 30 minutes for your telescope to acclimate to the temperature outdoors before you start observing with it.

Let Your Eyes Dark-Adapt

Don’t expect to go from a lighted house into the darkness of the outdoors at night and immediately see faint nebulas, galaxies, and star clusters—or even very many stars, for that matter. Your eyes take about 30 minutes to reach perhaps 80% of their full dark-adapted sensitivity. As your eyes become dark-adapted, more stars will glimmer into view and you’ll be able to see fainter details in objects you view in your telescope.

To see what you’re doing in the darkness, use a red-filtered flashlight rather than a white light. Red light does not spoil your eyes’ dark adaptation like white light does. A flashlight with a red LED light is ideal, or you can cover the front of a regular incandescent flashlight with red cellophane or paper. Beware, too, that nearby porch, streetlights, and car headlights will ruin your night vision.

Eyepiece Selection

Magnification, or power, is determined by the focal length of the telescope and the focal length of the eyepiece being used. Therefore, by using eyepieces of different focal lengths, the resultant magnification can be varied. It is quite common for an observer to own five or more eyepieces to access a wide range of magnifications. This allows the observer to choose the best eyepiece to use depending on the object being viewed and viewing conditions. The StarBlast II 4.5 EQ comes with two eyepieces, which will suffice nicely to begin with.

Magnification is calculated as follows:

$$\frac{\text{Telescope Focal Length (mm)}}{\text{Eyepiece Focal Length (mm)}} = \text{Magnification}$$

For example, the StarBlast II 4.5 EQ has a focal length of 450mm, which when used with the supplied 25mm eyepiece yields:

$$\frac{450 \text{ mm}}{25 \text{ mm}} = 18x$$

The magnification provided by the 10mm eyepiece is:

$$\frac{450 \text{ mm}}{10 \text{ mm}} = 45x$$

The maximum attainable magnification for a telescope is directly related to how much light it can gather. The larger the aperture, the more magnification is possible. In general, a figure of 50x per inch of aperture is the maximum attainable for most telescopes. Your StarBlast II 4.5 EQ has an aperture of 4.5 inches, so the

maximum magnification would be about 225x. This level of magnification assumes you have ideal conditions for observing.

Keep in mind that as you increase magnification, the brightness of the object viewed will decrease; this is an inherent principle of the laws of physics and cannot be avoided. If magnification is doubled, an image appears four times dimmer. If magnification is tripled, image brightness is reduced by a factor of nine!

Start by centering the object you wish to see in the 25mm eyepiece. Then you may want to increase the magnification to get a closer view. If the object is off-center (i.e., it is near the edge of the field of view) you will lose it when you increase magnification, since the field of view will be narrower with the higher-powered eyepiece.

To change eyepieces, first loosen the securing thumbscrews on the focuser drawtube. Then carefully lift the eyepiece out of the drawtube. Do not tug or pull the eyepiece to the side, as this will knock the telescope off its target. Replace the eyepiece with the new one by sliding it gently into the drawtube. Re-tighten the thumbscrews, and refocus for your new magnification.

What to Expect

So what will you see with your telescope? You should be able to see bands on Jupiter, the rings of Saturn, craters on the Moon, the waxing and waning of Venus, and many bright deep-sky objects. Do not expect to see color as you do in NASA photos, since those are taken with long-exposure cameras and have “false color” added. Our eyes are not sensitive enough to see color in deep-sky objects except in a few of the brightest ones.

Objects to Observe

Now that you are all set up and ready to go, one critical decision must be made: what to look at?

A. The Moon

With its rocky surface, the Moon is one of the easiest and most interesting objects to view with your telescope. Lunar craters, maria, and even mountain ranges can all be clearly seen from a distance of 238,000 miles away! With its ever-changing phases, you’ll get a new view of the Moon every night. The best time to observe our one and only natural satellite is during a partial phase, that is, when the Moon is not full. During partial phases, shadows are cast on the surface, which reveal more detail, especially right along the border between the dark and light portions of the disk (called the “terminator”). A full Moon is too bright and devoid of surface shadows to yield a pleasing view. Make sure to observe the Moon when it is well above the horizon to get the sharpest images.

Use an optional Moon filter to dim the Moon when it is very bright. It simply threads onto the bottom of the eyepieces (you must first remove the eyepiece from the focuser to attach a filter). You’ll find that the Moon filter improves viewing comfort, and also helps to bring out subtle features on the lunar surface.

B. The Planets

The planets don’t stay put like the stars, so to find them you should refer to the monthly star charts at telescope.com, or to charts published monthly in *Astronomy*, *Sky & Telescope*, or other astronomy magazines. Venus, Mars, Jupiter, and Saturn

are the brightest objects in the sky after the Sun and the Moon. Other planets may be visible but will likely appear star-like. Because planets are quite small in apparent size, optional higher-power eyepieces are recommended and often needed for detailed observations.

C. The Sun

You can change your nighttime telescope into a daytime Sun viewer by installing an optional full-aperture solar filter over the front opening of the StarBlast II 4.5 EQ. The primary attraction is sunspots, which change shape, appearance, and location daily. Sunspots are directly related to magnetic activity in the Sun. Many observers like to make drawings of sunspots to monitor how the Sun is changing from day to day.

Important Note: Do not look at the Sun with any optical instrument without a professionally made solar filter, or permanent eye damage could result.

D. The Stars

Stars will appear like twinkling points of light. Even powerful telescopes cannot magnify stars to appear as more than a point of light. You can, however, enjoy the different colors of the stars and locate many pretty double and multiple stars. The famous “Double-Double” in the constellation Lyra and the gorgeous two-color double star Albireo in Cygnus are favorites. Defocusing a star slightly can help bring out its color.

E. Deep-Sky Objects

Under dark skies, you can observe a wealth of fascinating deep-sky objects, including gaseous nebulas, open and globular star clusters, and a variety of different types of galaxies. Most deep-sky objects are very faint, so it is important you find an observing site well away from light pollution.

To find deep-sky objects with your telescope, you first need to become reasonably familiar with the night sky. Unless you know how to recognize the constellation Orion, for instance, you won't have much luck locating the Orion Nebula. A simple planisphere, or star wheel, can be a valuable tool for learning the constellations and seeing which ones are visible in the sky on a given night. Once you have identified a few constellations, a good star chart or atlas will come in handy for helping locate interesting deep-sky objects to view within the constellations.

Do not expect these objects to appear like the photographs you see in books and magazines; most will look like dim gray smudges. Our eyes are not sensitive enough to see color in deep-sky objects except in a few of the brightest ones. But as you become more experienced and your observing skills get sharper, you will be able to ferret out more and more subtle details and structure.

8. Care and Maintenance

If you give your telescope reasonable care, it will last a lifetime. Store it in a clean, dry, dust-free place, safe from rapid changes in temperature and humidity. Do not store the telescope outdoors, although storage in a garage or shed is OK. Small components like eyepieces and other accessories should be kept in a protective box or storage case. Keep the dust cover on the front of the telescope when it is not in use.

Your StarBlast II 4.5 EQ requires very little mechanical maintenance. The optical tube has a smooth painted finish that is fairly scratch-resistant. If a scratch does appear on the tube, it will not harm the telescope. If you wish, you may apply some auto touch-up paint to the scratch. Smudges on the tube can be wiped off with a soft cloth and household cleaning fluid.

Cleaning Optics

Any quality optical lens cleaning tissue and optical lens cleaning fluid specifically designed for multi-coated optics can be used to clean the exposed lenses of your eyepieces. Never use regular glass cleaner or cleaning fluid designed for eyeglasses. Before cleaning, remove any loose particles or dust from the lens with a blower bulb or soft brush. Then apply some cleaning fluid to a tissue, never directly on the optics. Wipe the lens gently in a circular motion, then remove any excess fluid with a fresh lens tissue. Oily fingerprints and smudges may be removed using this method. Use caution; rubbing too hard may scratch the lens. On larger lenses, clean only a small area at a time, using a fresh lens tissue on each area. Never reuse tissues.

You should not have to clean the telescope's mirrors very often, if ever. Covering the front opening of the telescope with the dust cover when it is not in use will prevent dust from accumulating on the mirrors. Small specks of dust or flecks of paint have virtually no effect on the visual performance of the telescope.

You should rarely if ever have to clean the telescope's mirrors. Covering the telescope with the dust cap when it is not in use will help prevent dust from accumulating on the mirrors. Light dust or other particles on the mirrors have virtually no effect on the visual performance of the telescope. Improper cleaning can scratch mirror coatings. If either mirror does need cleaning please email us at: support@telescope.com or contact Orion Technical Support at (800) 447-1001 to learn the correct procedure.

When bringing the telescope inside after an evening's viewing it is normal for moisture to accumulate on the mirrors and lenses due to the change in temperature. We suggest leaving the telescope and eyepieces uncovered overnight to allow the condensation to evaporate.

9. Specifications

Primary mirror: 4.5" (114mm) diameter, parabolic, center marked

Effective focal length: 450mm

Focal ratio: f/4

Minor axis of secondary mirror: 1.3" (34mm)

Mirror coatings: Aluminum with silicoon dioxide (SiO₂) overcoat

Focuser: Rack-and-pinion, accepts 1.25" eyepieces

Eyepieces: 25mm and 10mm Plossl eyepieces, fully coated with multi-coatings, 1.25" barrel diameter, threaded for Orion filters

Eyepiece magnification: 18x (with 25mm eyepiece) and 45x (with 10mm eyepiece)

Finder scope: EZ Finder II reflex sight

Mount: German equatorial

Tripod: Aluminum

Motor drives: Optional

Total instrument weight: 15 lbs.

One-Year Limited Warranty

This Orion product is warranted against defects in materials or workmanship for a period of one year from the date of purchase. This warranty is for the benefit of the original retail purchaser only. During this warranty period Orion Telescopes & Binoculars will repair or replace, at Orion's option, any warranted instrument that proves to be defective, provided it is returned postage paid. Proof of purchase (such as a copy of the original receipt) is required. This warranty is only valid in the country of purchase.

This warranty does not apply if, in Orion's judgment, the instrument has been abused, mishandled, or modified, nor does it apply to normal wear and tear. This warranty gives you specific legal rights. It is not intended to remove or restrict your other legal rights under applicable local consumer law; your state or national statutory consumer rights governing the sale of consumer goods remain fully applicable.

For further warranty information, please visit www.OrionTelescopes.com/warranty.



Corporate Offices: 89 Hangar Way, Watsonville CA 95076 - USA
Toll Free USA & Canada: (800) 447-1001
International: +1(831) 763-7000
Customer Support: support@telescope.com

Copyright © 2022 Orion Telescopes & Binoculars. All Rights Reserved. No part of this product instruction or any of its contents may be reproduced, copied, modified or adapted, without the prior written consent of Orion Telescopes & Binoculars.